

QUICK START

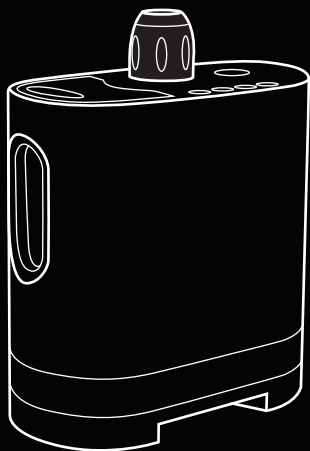

SteamOne

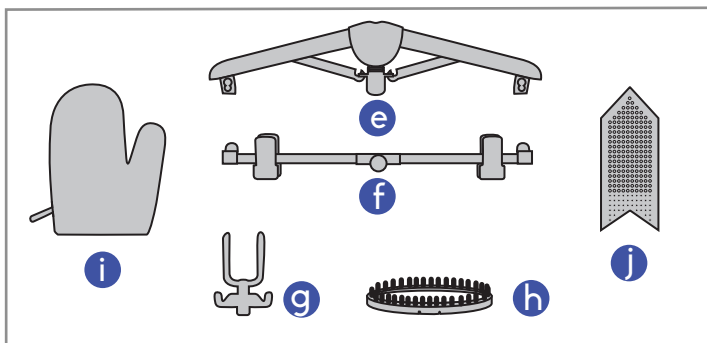
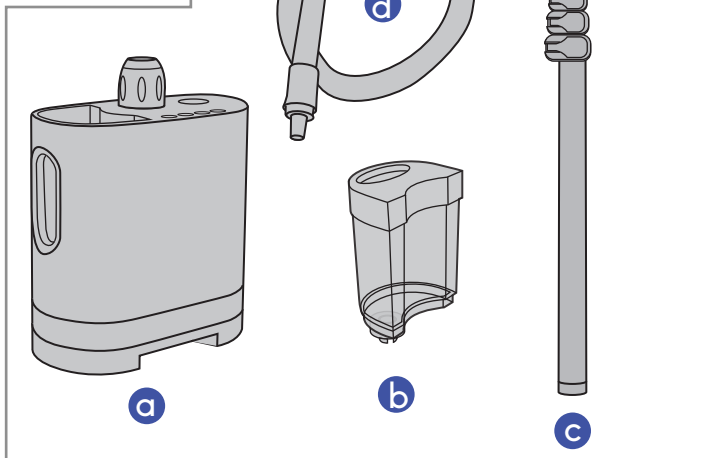

SteamOne

1

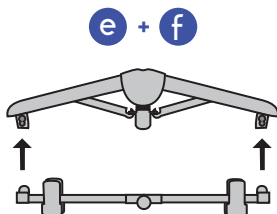

2

a + c

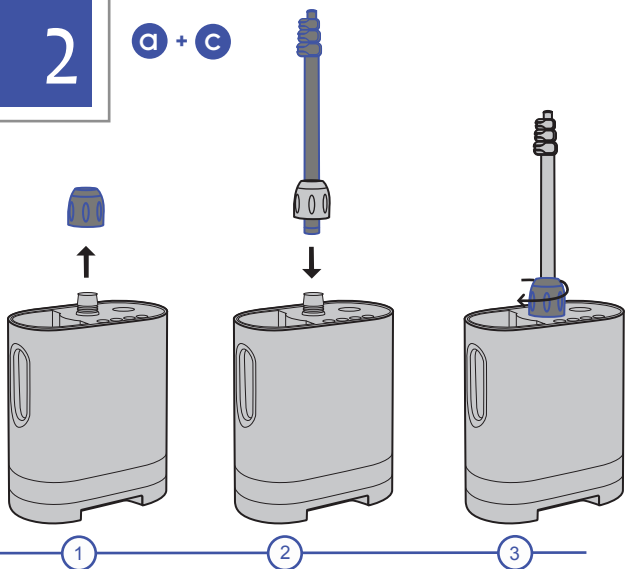

SteamOne

3

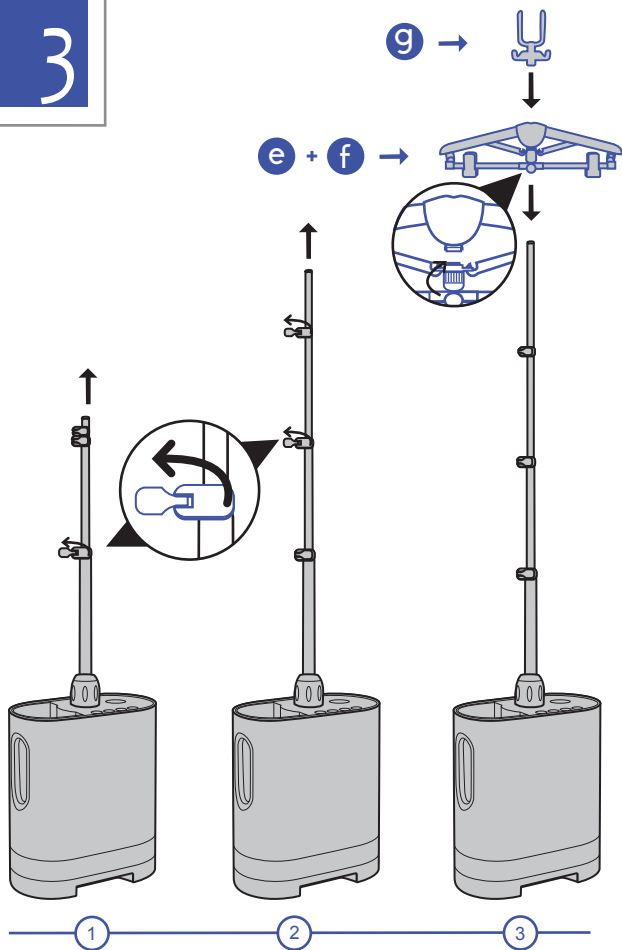

SteamOne

4

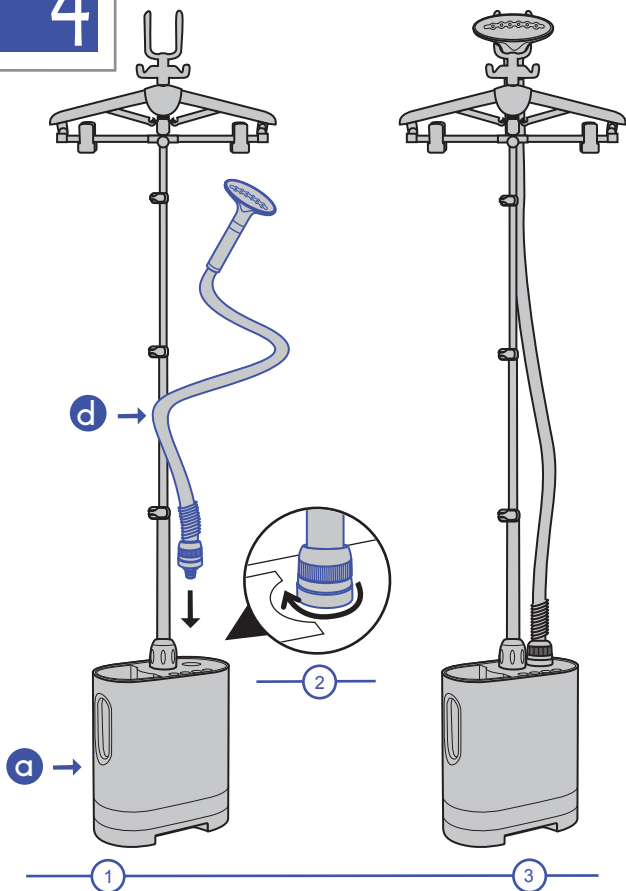

SteamOne



b →

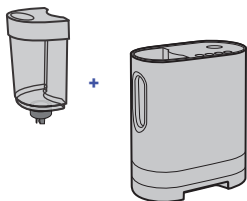

1

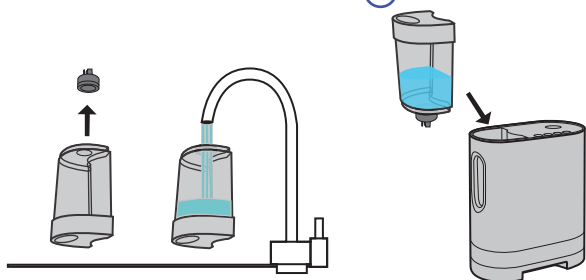

2

3

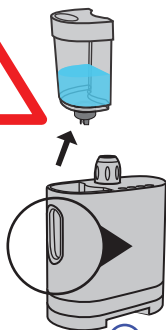

4

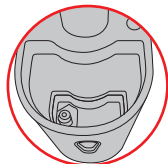
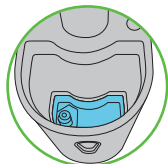

SteamOne

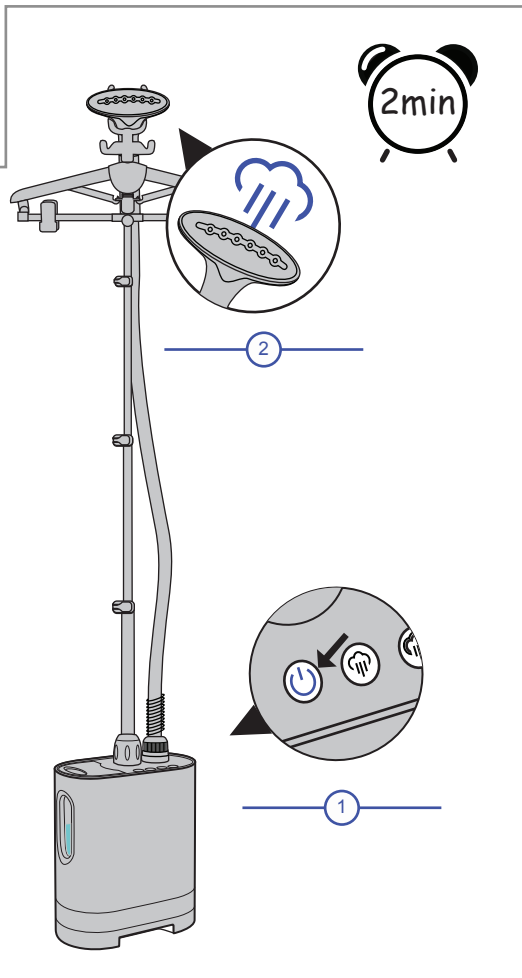

SteamOne



e

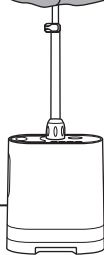

g

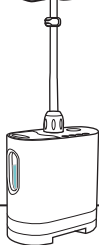

e + f

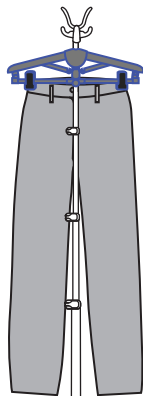

SteamOne

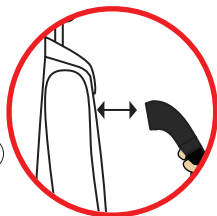

1



2

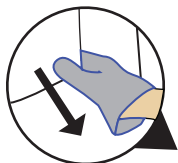

3

SteamOne



h



1

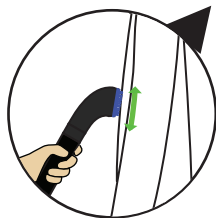

2

j

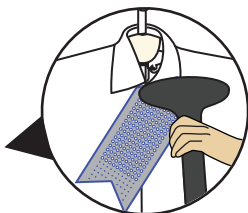
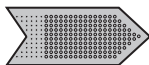

1

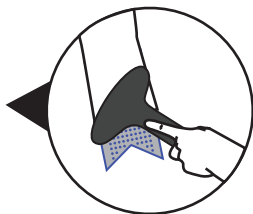

2



SteamOne



OFF

0

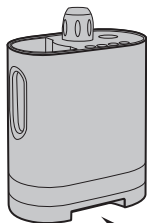

a

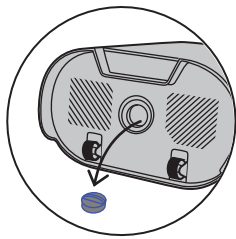
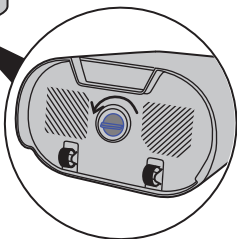

1

b

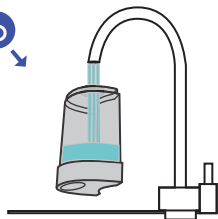

2

SteamOne

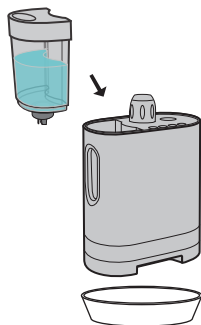

3

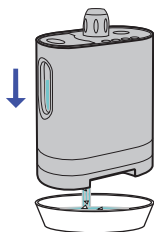

4

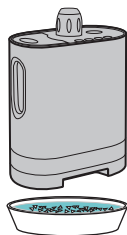

SteamOne