

# QUICK START

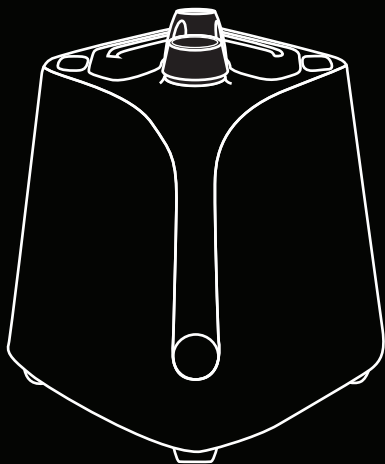

SteamOne

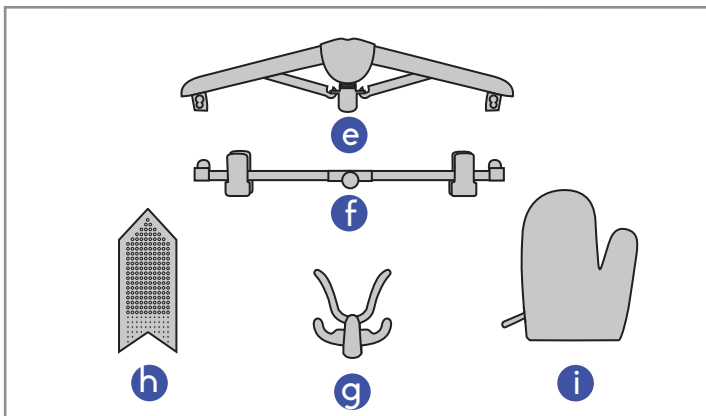
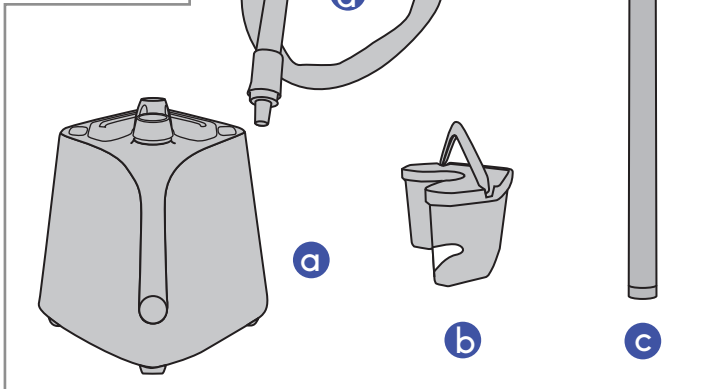

SteamOne

1

e + f

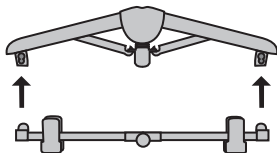

2

a + c

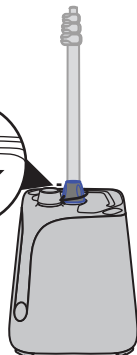
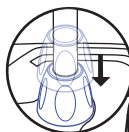
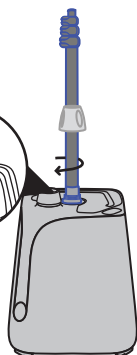
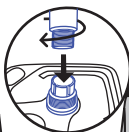
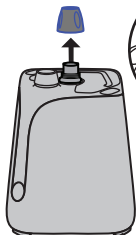
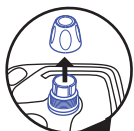

1

2

3

SteamOne

3

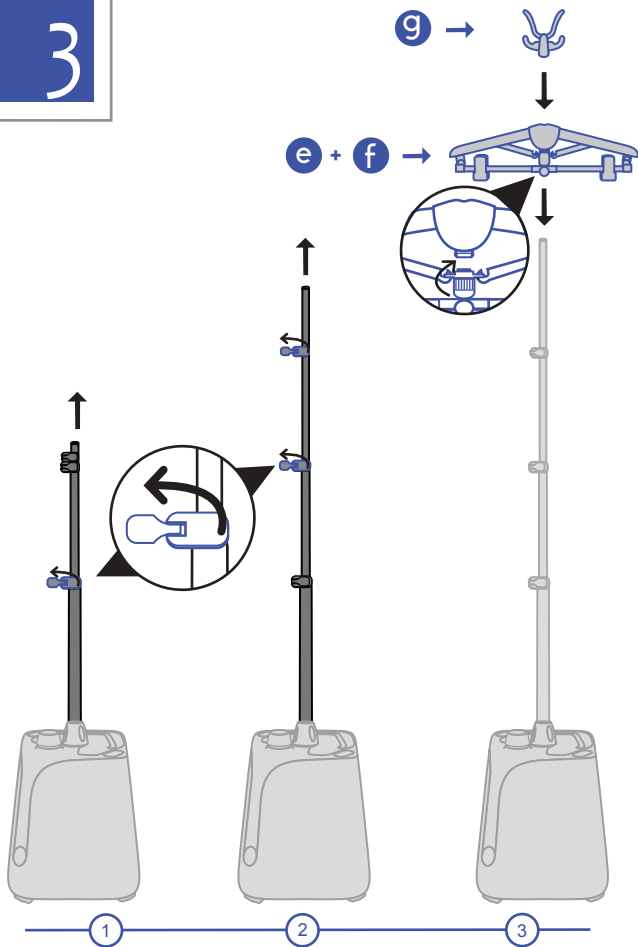

SteamOne

4

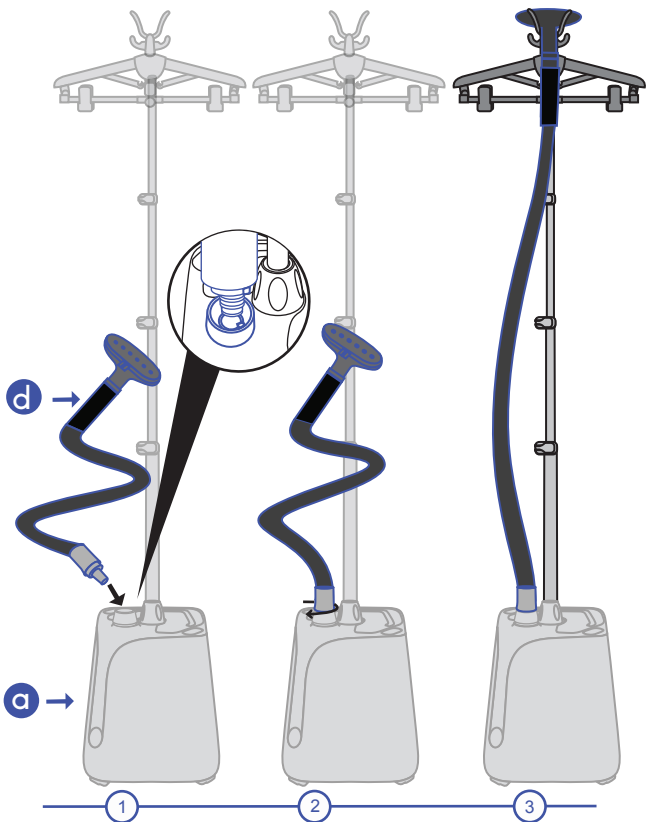

SteamOne

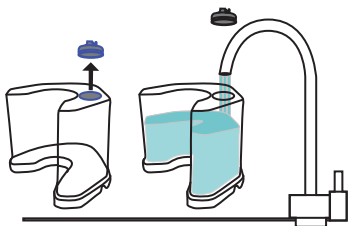
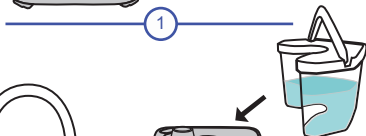

2



3

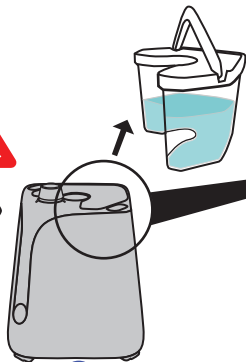

4



SteamOne

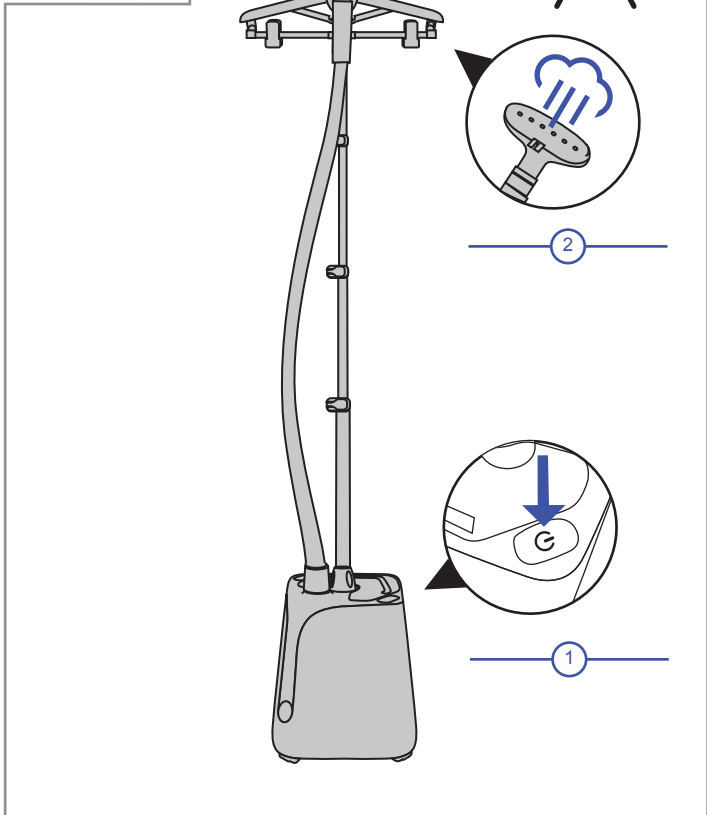

SteamOne

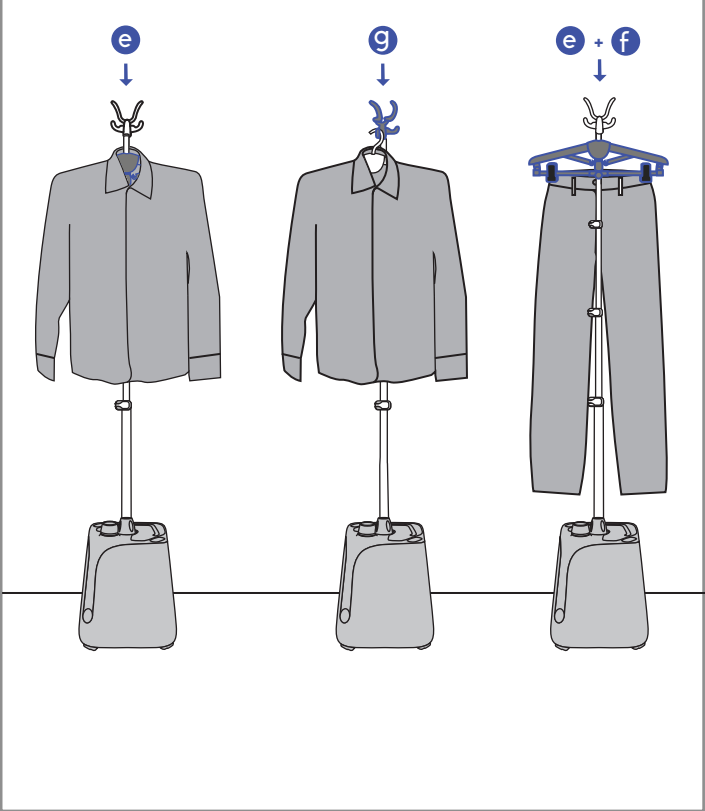

SteamOne



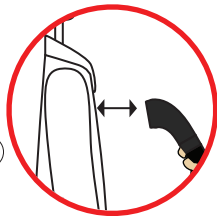

1



2

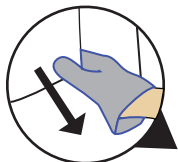

3

SteamOne

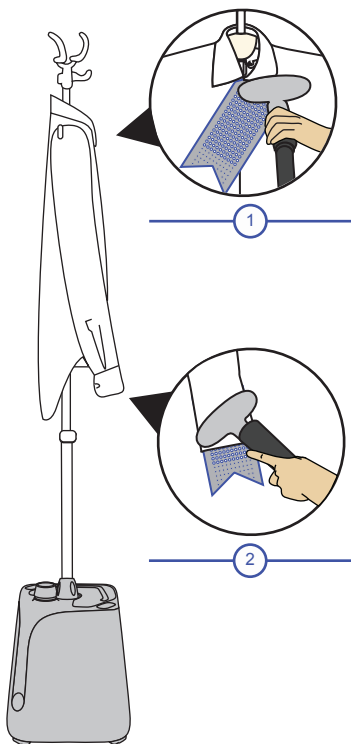
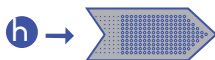

SteamOne

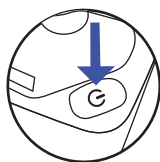

OFF

0

a →

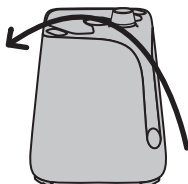

1

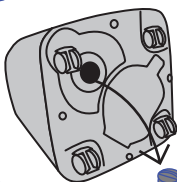
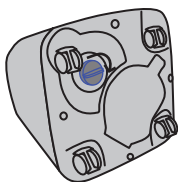

2

b →

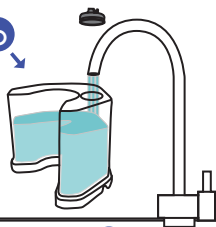

3

SteamOne



4

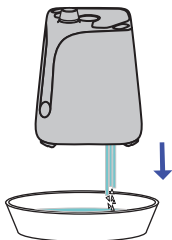

5

